

# 150V, 200A, 3.7mΩ N-channel Power SGT MOSFET

## JMSH1504NE

### Features

- Excellent  $R_{DS(ON)}$  and Low Gate Charge
- 100% UIS TESTED
- 100%  $\Delta V_{ds}$  TESTED
- Halogen-free; RoHS-compliant
- Pb-free plating

### Applications

- Load Switch
- PWM Application
- Power Management

### Product Summary

Parameters	Value	Unit
$V_{DSS}$	150	V
$V_{GS(th\_Typ)}$	3.3	V
$I_D(@V_{GS}=10V)$	200	A
$R_{DS(ON)\_Typ}(@V_{GS}=10V)$	3.7	mΩ

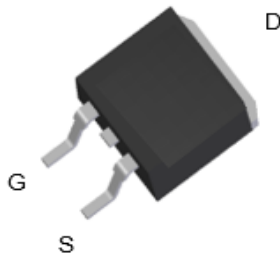

TO-263-3L

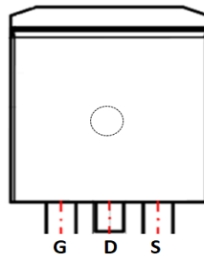

Pin Assignment

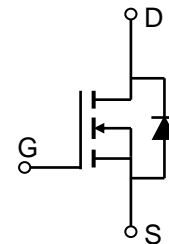

Schematic Diagram

### Ordering Information

Device	Marking	MSL	Form	Package	Reel(pcs)	Per Carton (pcs)
JMSH1504NE	JMSH1504NE	3	Tape&Reel	TO-263-3L	800	4000

### Absolute Maximum Ratings (@ $T_C = 25^\circ\text{C}$ unless otherwise specified)

Symbol	Parameter	Value	Unit
$V_{DS}$	Drain-to-Source Voltage	150	V
$V_{GS}$	Gate-to-Source Voltage	$\pm 20$	V
$I_D$	Continuous Drain Current	$T_C = 25^\circ\text{C}$	200
		$T_C = 100^\circ\text{C}$	141
$I_{DM}$	Pulsed Drain Current <sup>(1)</sup>	Refer to Fig.4	A
$E_{AS}$	Single Pulsed Avalanche Energy <sup>(2)</sup>	1309	mJ
$P_D$	Power Dissipation	$T_C = 25^\circ\text{C}$	233
		$T_C = 100^\circ\text{C}$	93
$T_J, T_{STG}$	Junction & Storage Temperature Range	-55 to 150	$^\circ\text{C}$

### Thermal Characteristics

Symbol	Parameter	Max	Unit
$R_{\theta JA}$	Thermal Resistance, Junction to Ambient <sup>(3)</sup>	28	$^\circ\text{C/W}$
$R_{\theta JC}$	Thermal Resistance, Junction to Case	0.5	



**Electrical Characteristics** ( $T_J = 25^\circ\text{C}$  unless otherwise specified)

Symbol	Parameter	Conditions	Min.	Typ.	Max.	Unit
<b>Off Characteristics</b>						
$V_{(BR)DSS}$	Drain-Source Breakdown Voltage	$I_D = 250\mu\text{A}, V_{GS} = 0\text{V}$	150	-	-	V
$I_{DSS}$	Zero Gate Voltage Drain Current	$V_{DS} = 120\text{V}, V_{GS} = 0\text{V}$	-	-	1.0	$\mu\text{A}$
$I_{GSS}$	Gate-Body Leakage Current	$V_{DS} = 0\text{V}, V_{GS} = \pm 20\text{V}$	-	-	$\pm 100$	nA
<b>On Characteristics</b>						
$V_{GS(th)}$	Gate Threshold Voltage	$V_{DS} = V_{GS}, I_D = 250\mu\text{A}$	2.3	3.3	4.3	V
$R_{DS(ON)}$	Static Drain-Source ON-Resistance <sup>(4)</sup>	$V_{GS} = 10\text{V}, I_D = 20\text{A}$	-	3.7	4.5	m $\Omega$
<b>Dynamic Characteristics</b>						
$R_g$	Gate Resistance	$f = 1\text{MHz}$	-	4.1	-	$\Omega$
$C_{iss}$	Input Capacitance	$V_{GS} = 0\text{V}, V_{DS} = 75\text{V},$ $f = 1\text{MHz}$	6159	8622	11640	pF
$C_{oss}$	Output Capacitance		551	772	1042	pF
$C_{rss}$	Reverse Transfer Capacitance		19	26	36	pF
$Q_g$	Total Gate Charge	$V_{GS} = 0 \text{ to } 10\text{V}$ $V_{DS} = 75\text{V}, I_D = 20\text{A}$	90	125	169	nC
$Q_{gs}$	Gate Source Charge		33	46	62	nC
$Q_{gd}$	Gate Drain("Miller") Charge		23	32	43	nC
<b>Switching Characteristics</b>						
$t_{d(on)}$	Turn-On DelayTime	$V_{GS} = 10\text{V}, V_{DD} = 75\text{V}$ $I_D = 20\text{A}, R_{GEN} = 3\Omega$	-	32	-	ns
$t_r$	Turn-On Rise Time		-	60	-	ns
$t_{d(off)}$	Turn-Off DelayTime		-	87	-	ns
$t_f$	Turn-Off Fall Time		-	48	-	ns
<b>Body Diode Characteristics</b>						
$I_S$	Maximum Continuous Body Diode Forward Current		-	-	200	A
$I_{SM}$	Maximum Pulsed Body Diode Forward Current		-	-	800	A
$V_{SD}$	Body Diode Forward Voltage	$V_{GS} = 0\text{V}, I_S = 20\text{A}$	-		1.2	V
$t_{rr}$	Body Diode Reverse Recovery Time	$I_F = 20\text{A}, di/dt = 100\text{A}/\mu\text{s}$	80	111	150	ns
$Q_{rr}$	Body Diode Reverse Recovery Charge		-	428	-	nC

- Notes:
1. Repetitive Rating: Pulse Width Limited by Maximum Junction Temperature.
  2.  $E_{AS}$  condition: Starting  $T_J = 25^\circ\text{C}$ ,  $V_{DD} = 75\text{V}$ ,  $V_G = 10\text{V}$ ,  $R_G = 25\text{ohm}$ ,  $L = 3\text{mH}$ ,  $I_{AS} = 29.54\text{A}$ ,  $V_{DD} = 0\text{V}$  during time in avalanche.
  3.  $R_{\theta JA}$  is measured with the device mounted on a 1inch<sup>2</sup> pad of 2oz copper FR4 PCB.
  4. Pulse Test: Pulse Width  $\leq 300\mu\text{s}$ , Duty Cycle  $\leq 0.5\%$ .



## Typical Performance Characteristics

Figure 1: Power De-rating

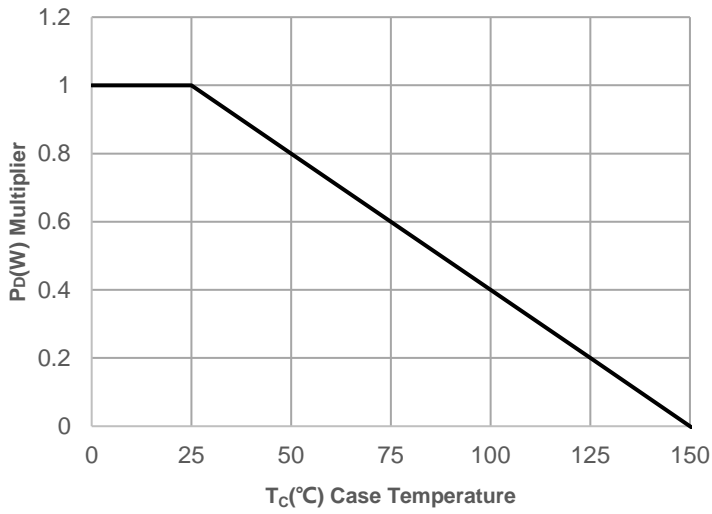

Figure 2: Current De-rating

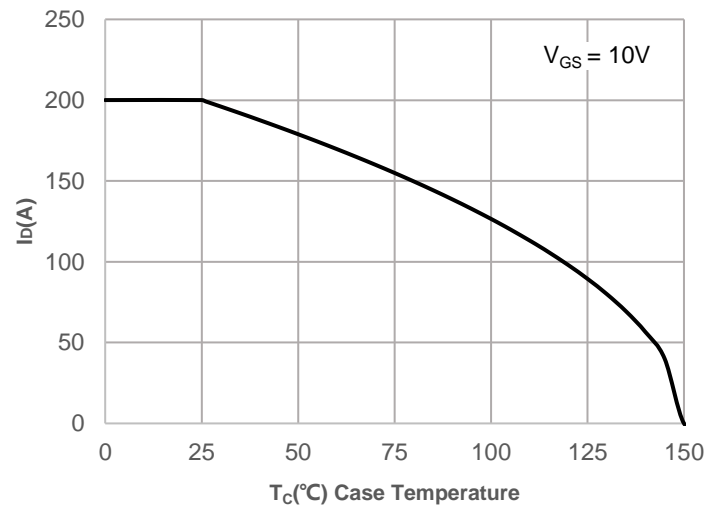

Figure 3: Normalized Maximum Transient Thermal Impedance

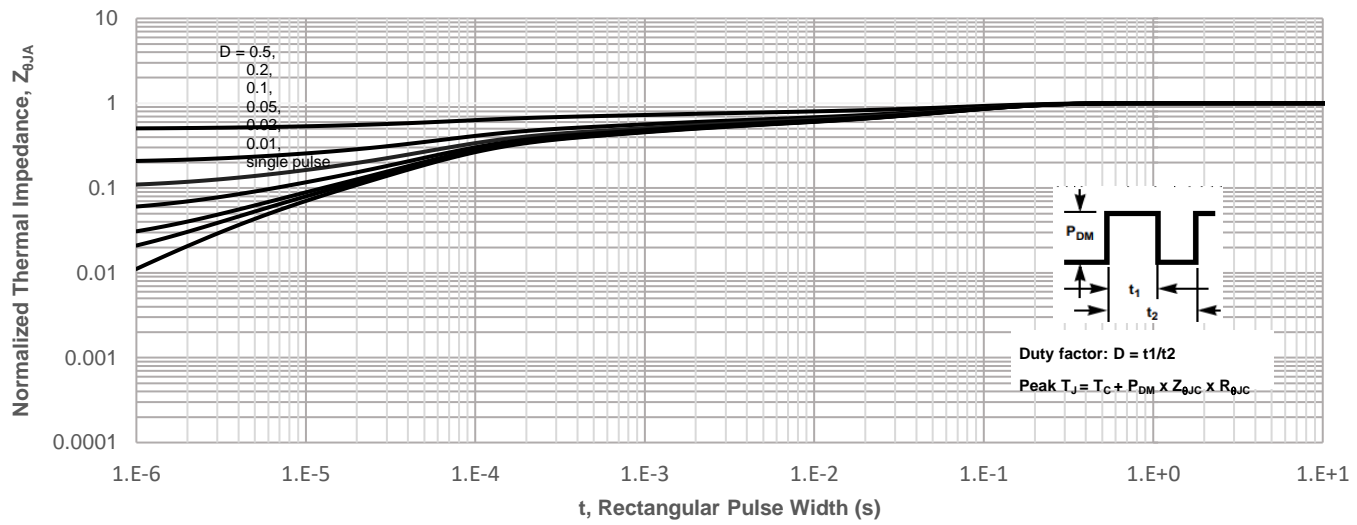
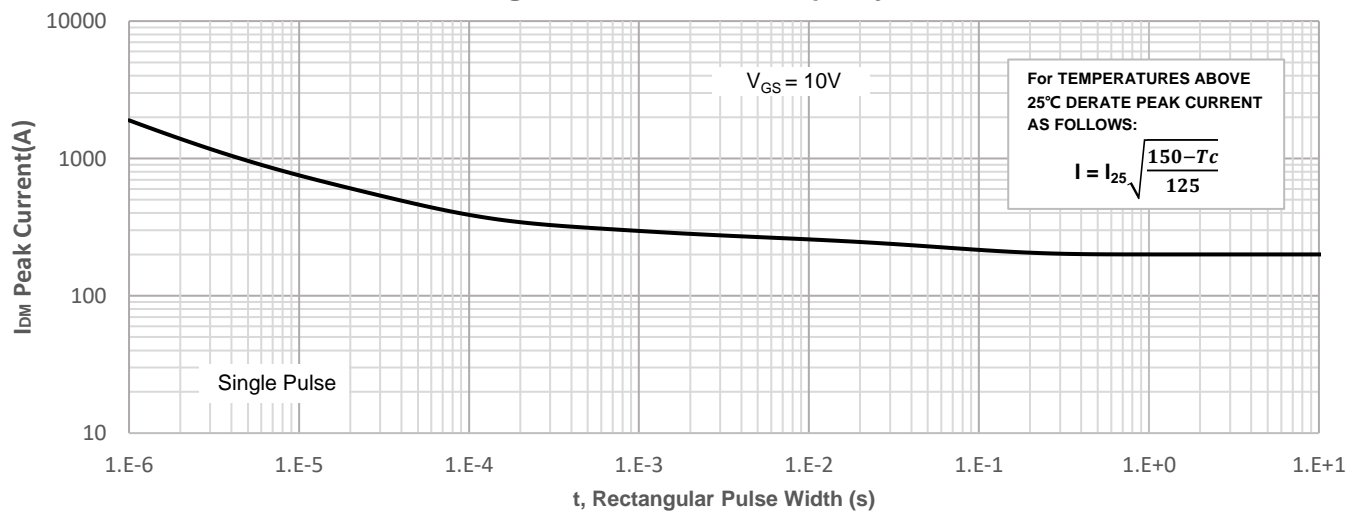
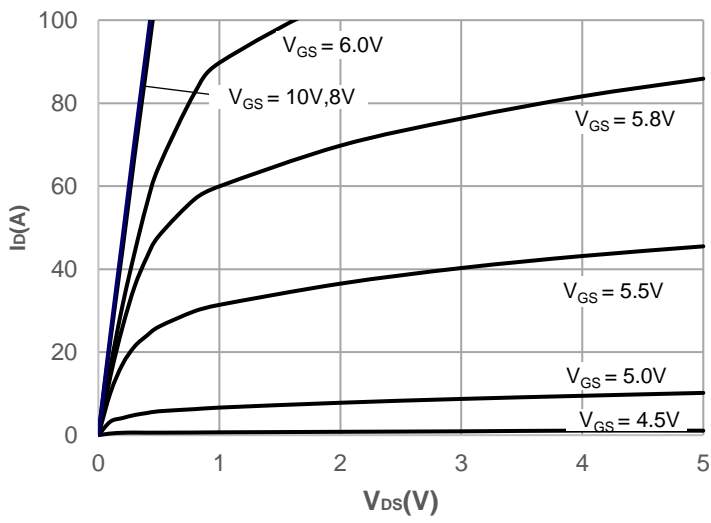
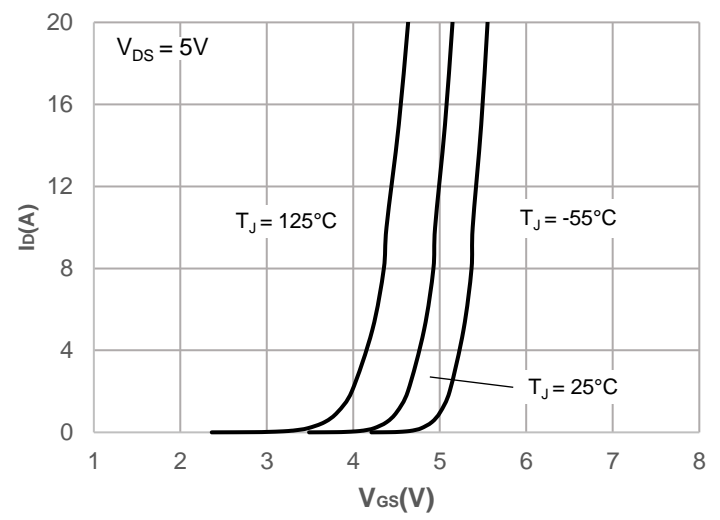
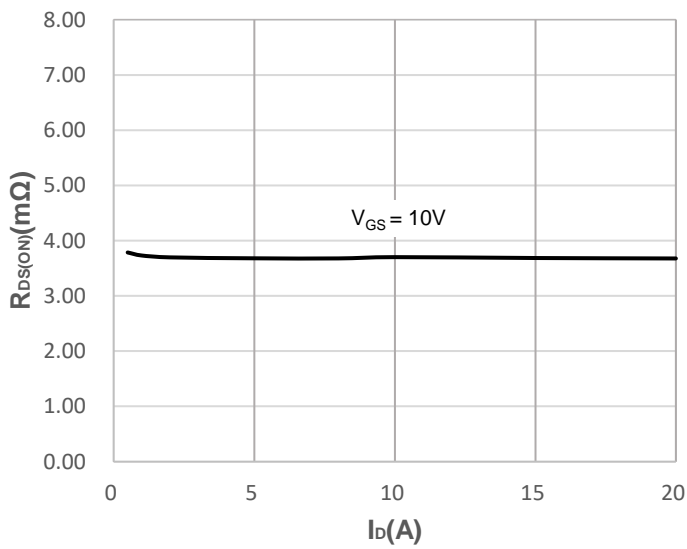
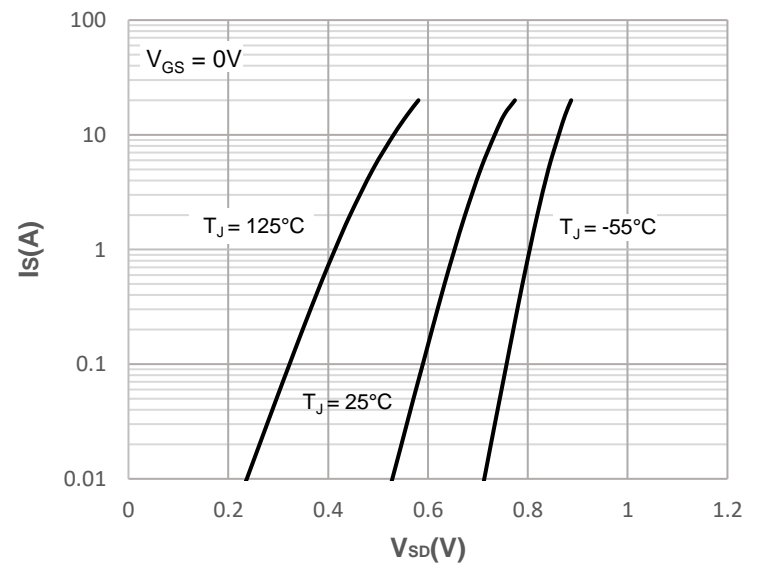
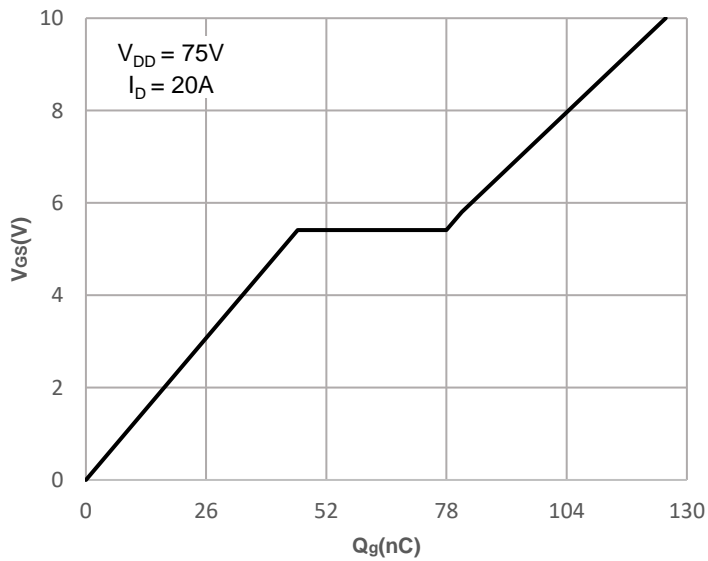
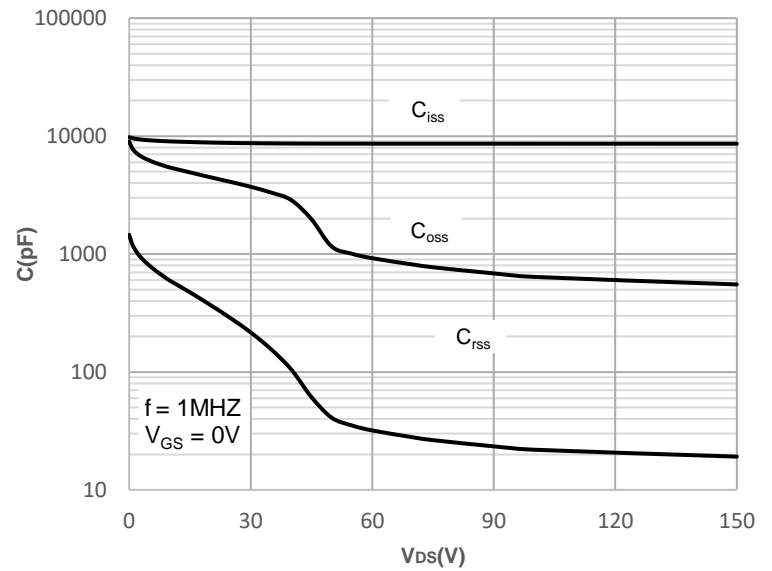

Figure 4: Peak Current Capacity



## Typical Performance Characteristics

**Figure 5: Output Characteristics**

**Figure 6: Typical Transfer Characteristics**

**Figure 7: On-resistance vs. Drain Current**

**Figure 8: Body Diode Characteristics**

**Figure 9: Gate Charge Characteristics**

**Figure 10: Capacitance Characteristics**

## Typical Performance Characteristics

Figure 11: Normalized Breakdown voltage vs. Junction Temperature

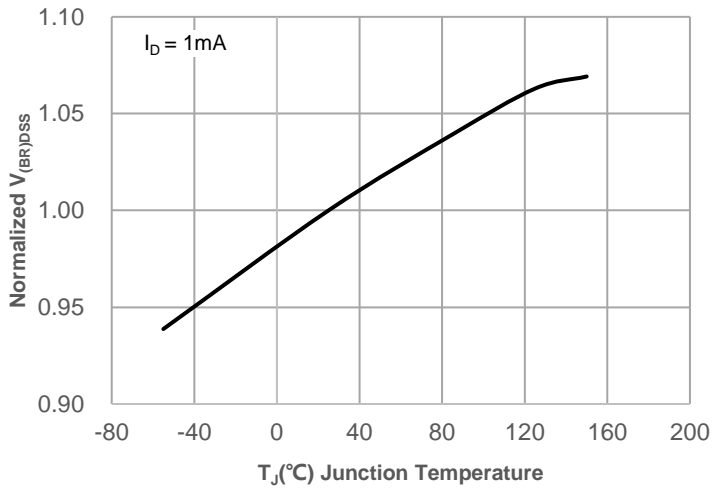

Figure 12: Normalized on Resistance vs. Junction Temperature

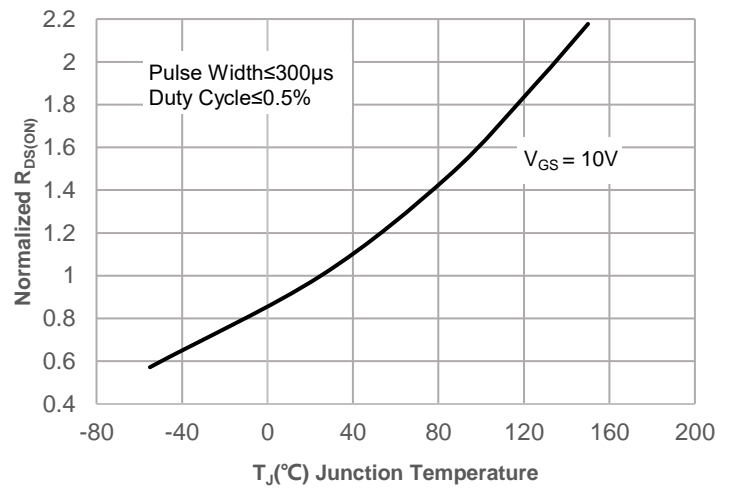

Figure 13: Normalized Threshold Voltage vs. Junction Temperature

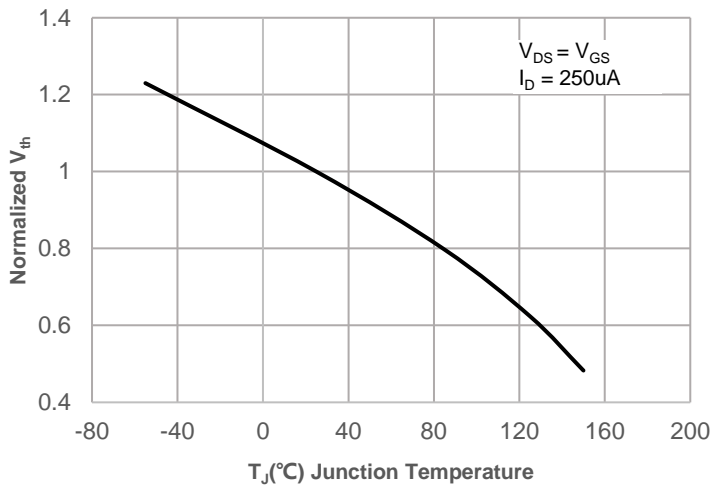

Figure 14: R\_DS(ON) vs. V\_GS

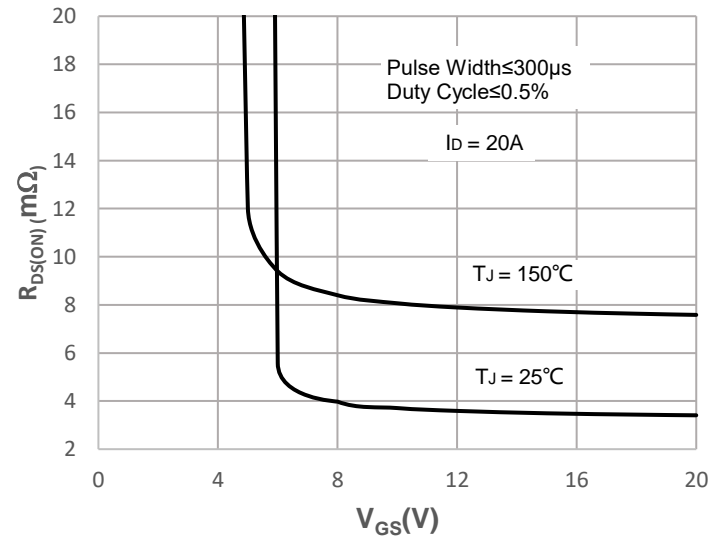
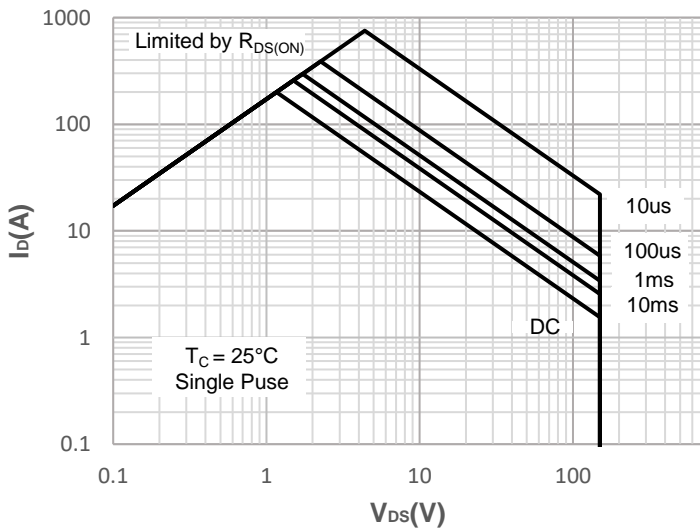

Figure 15: Maximum Safe Operating Area



### Test Circuit

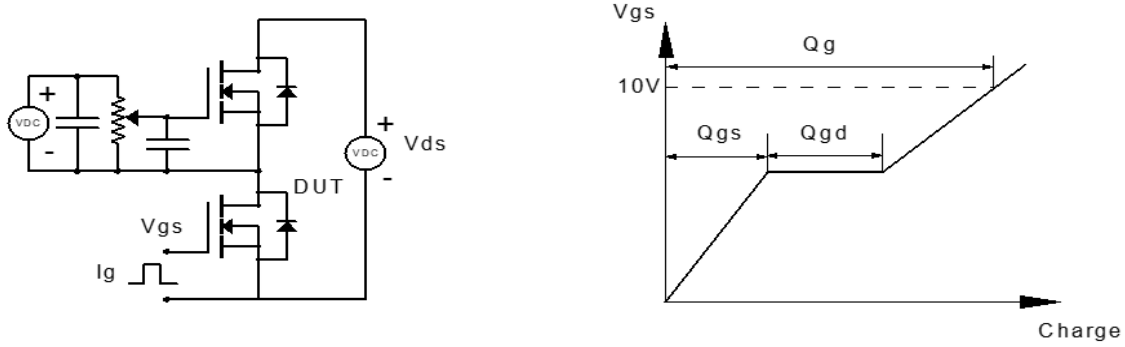

Figure 1: Gate Charge Test Circuit & Waveform

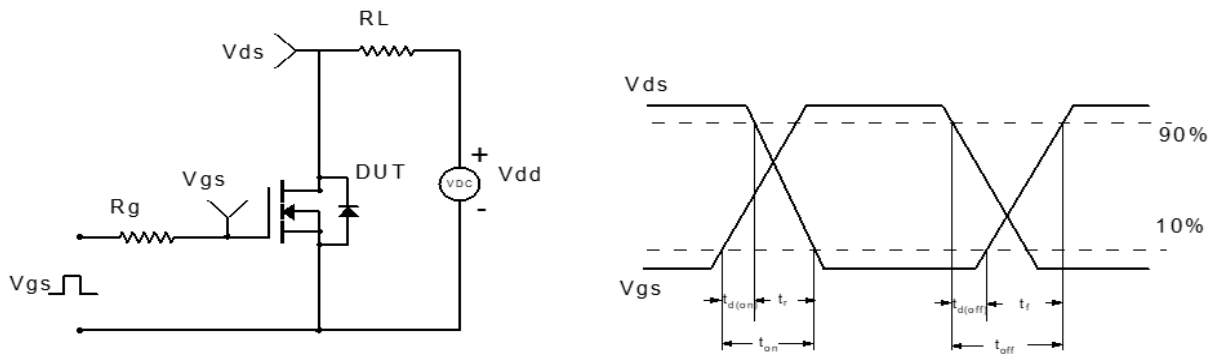

Figure 2: Resistive Switching Test Circuit & Waveform

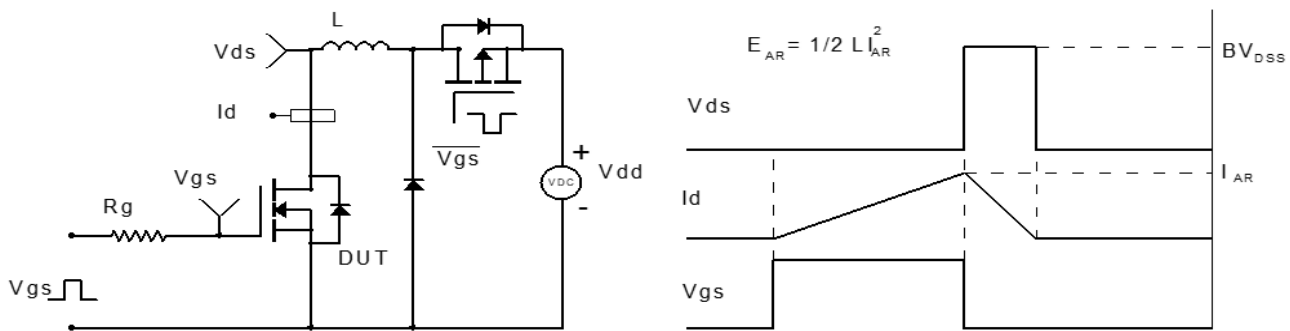

Figure 3: Unclamped Inductive Switching Test Circuit & Waveform

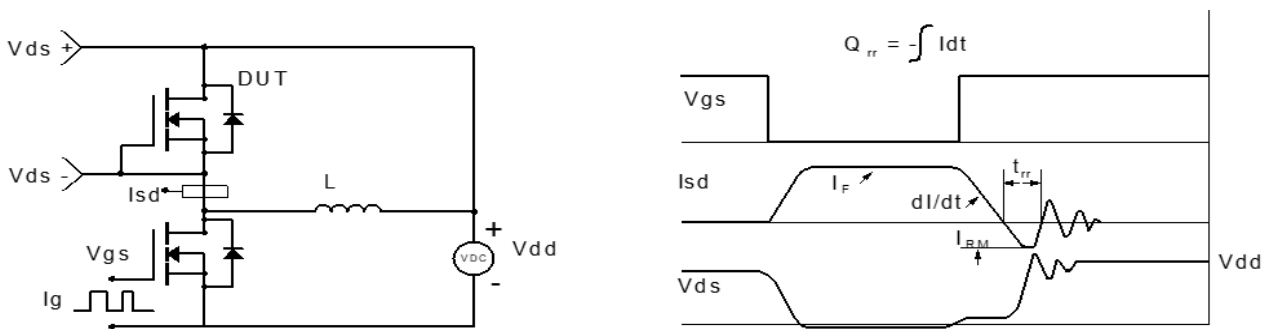
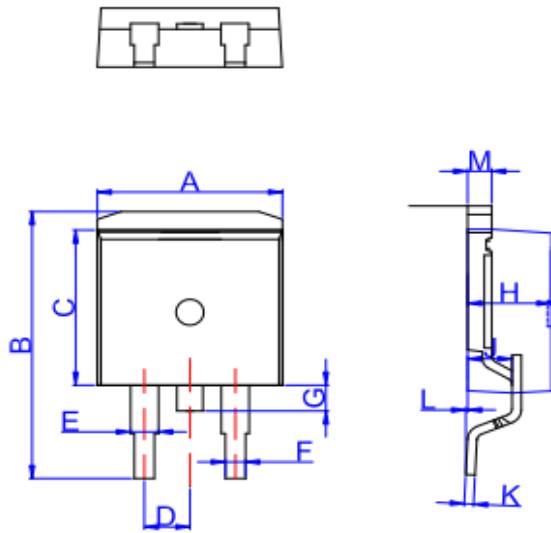
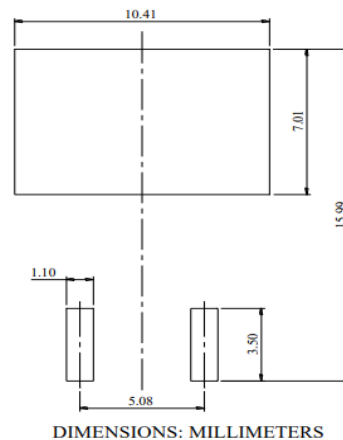

Figure 4: Diode Recovery Test Circuit & Waveform



**Package Mechanical Data(TO-263-3L)**

**TO-263**

Ref.	Dimensions					
	Millimeters			Inches		
	Min.	Typ.	Max.	Min.	Typ.	Max.
A	9.90		10.20	0.390		0.402
B	14.70		15.80	0.579		0.622
C	9.4		9.6	0.37		0.378
D		2.54			0.100	
E	1.20		1.40	0.047		0.055
F	0.75		0.85	0.029		0.033
G			1.75			0.069
H	4.40		4.70	0.173		0.185
J	2.30		2.70	0.091		0.106
K	0.38		0.55	0.015		0.022
L	0	0.10	0.25	0	0.004	0.010
M	1.25		1.35	0.049		0.053

**Recommended Footprint**

Information furnished in this document is believed to be accurate and reliable. However, Jiangsu JieJie Microelectronics Co.,Ltd assumes no responsibility for the consequences of use without consideration for such information nor use beyond it. Information mentioned in this document is subject to change without notice, apart from that when an agreement is signed, Jiangsu JieJie complies with the agreement. Products and information provided in this document have no infringement of patents. Jiangsu JieJie assumes no responsibility for any infringement of other rights of third parties which may result from the use of such products and information.

is a registered trademark of Jiangsu JieJie Microelectronics Co.,Ltd.

